

Tungaloy

Member IMC Group

Keeping the Customer First

Tungaloy Report No. 401-E

DRILLLINE

Indexable drills for large diameter machining

NEW

TUNGDRILLBIG

New solution

– Adjustable tool reduces the number of drills required



New structure offers one drill body that covers several diameter sizes!

Features

Drills range from $\varnothing 55$ mm ~ $\varnothing 80$ mm,
 $L/D = 2.5!$

1

Highly rigid body and optimized insert position

Provides well balanced cutting forces and stable machining conditions for highly accurate hole making.

Setting plate for adjusting diameter

2 Tool diameter is adjustable by exchanging setting plates

TungDrillBig covers the diameter range from $\varnothing 55$ mm ~ $\varnothing 80$ mm with 5 drill body sizes. This reduces the number of large drills required.

3 The cartridge system extends the life of the drill body

By exchanging cartridges the drill body maintains a long tool life even if the insert seat is damaged.

Cartridge

4 TungDrillBig can use the same inserts as the TungDrillTwisted

9 types of inserts are available for drilling a variety of materials on a wide range of machines.



Chipbreakers

DG chipbreaker for mild steel

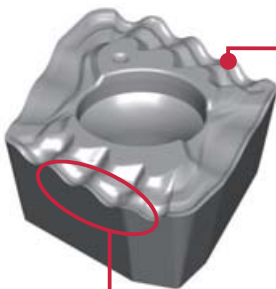

Wavy cutting edge

Creates wavy chips that are easily controlled and broken.

Chipbreaker for making short chips

Controls the direction of chip flow to break chips with cracks. This prevents long chips from tangling around the tool body.

- Applicable for low to high speed machining
- Prevents long chips from tangling around the tool body, even when the cutting speed is low on heavy machines with a low-rpm spindle

Chips with low cutting speed, $V_c = 80$ m/min



DG type



Competitor

Work material : SS400 / St42-1
Feed : $f = 0.08$ mm/rev

DJ type

General purpose chipbreaker for almost all applications. Features low cutting forces and allows stable drilling.



Chipbreaker with peripheral edge

Deeply formed chip groove performs exceptionally free cutting action with effective chipbreaking.

Chipbreaker for central edge

Relatively shallow chip groove prevents chips from packing.

Low cutting forces and long tool life

Bumps and grooves formed on the rake face reduce the contact area with chips reducing cutting forces and delivering longer tool life.

DW type

In comparison with conventional inserts, this chipbreaker allows higher feeds and produces superior surface finishes.



Wiper design

Can improve surface finish at normal feeds and minimizes surface degradation at high feeds.

Extraordinarily strengthened corner

Increased land width plus a two step relief angle strengthens the corner section.

Strong chipbreaker for high feeds

Can forcibly curl thick chips produced at high feeds, causing them to break into short sections. It also allows for large volume chip removal.

DS type

Performs excellent chip control for gummy materials such as stainless steels and low carbon steels.

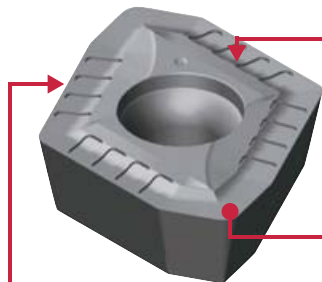

Entirely new rake face design

Can effectively form gummy material chips into short sections.

Strengthened corner

Strengthened corner geometry minimizes insert breakage even when drilling stainless steels.

Sharp cutting edges

Exceptionally free cutting action improves chip control.

Cutting performance

Chip control

Chips are well controlled and shortened.

Tool diameter ϕD_c (mm)	$\phi 57$ (without setting plate)		$\phi 62$ (with setting plate)	
Feed f (mm/rev)	0.08	0.13	0.08	0.13
SCM440				
S45C				

▶ No chip control difference with or without setting plates. This ensures stable machining in each diameter range.

Drill : TDX54-62F50-2.5 Cutting speed : $V_c = 160$ m/min
 Insert : XPMT08T308R-DJ Feed : $f = 0.08 \sim 0.13$ mm/rev
 Grade : AH725 Hole diameter : $\phi 57, \phi 62$ mm
 Work material : SCM440, S45C Hole depth : $H = 70$ mm
 (42CrMo4, C45) Coolant : Wet (Intrrenal)
 Machine : Vertical M/C (BT50)

Hole accuracy

Highly rigid body and optimized insert position provides stable machining for high accuracy.

Hole enlargement

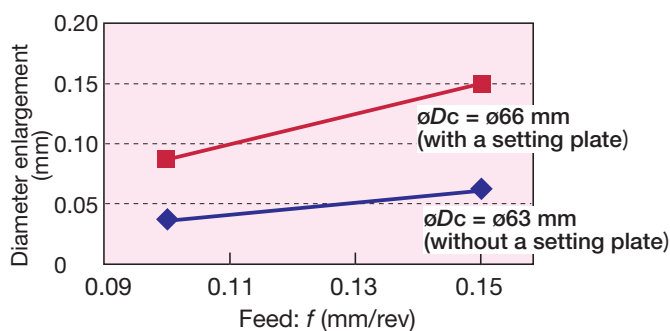

▶ The value of diameter enlargement with setting plate is similar to the value without setting plate.

Change of hole diameter

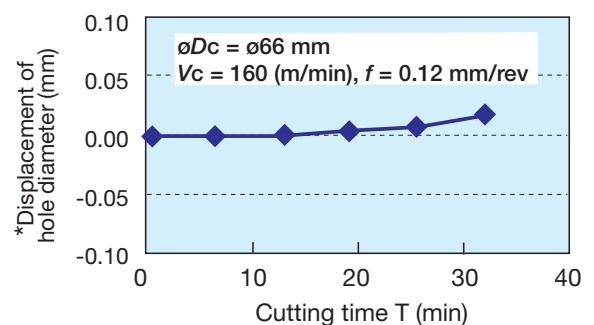

▶ The variation in hole diameter is minimal when drilling continuously.

* (Above graph shows the displacement value compared with diameter of 1st hole.)

Drill : TDX63-66F50-2.5 Cutting speed : $V_c = 160$ m/min
 Insert : XPMT08T308R-DJ Feed : $f = 0.10 \sim 0.15$ mm/rev
 Grade : AH725 Hole diameter : $\phi 63, \phi 66$ mm
 Work material : SCM440 (42CrMo4) Hole depth : $H = 70$ mm
 Machine : Vertical M/C (BT50) Coolant : Wet (Intrrenal)

Drill

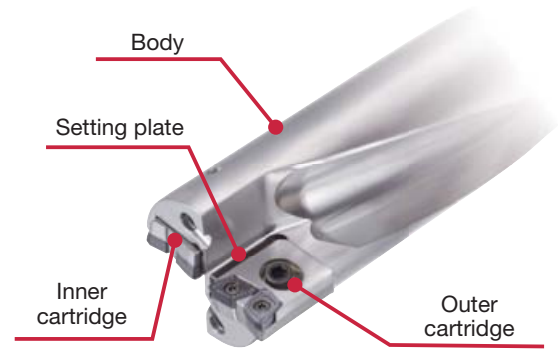
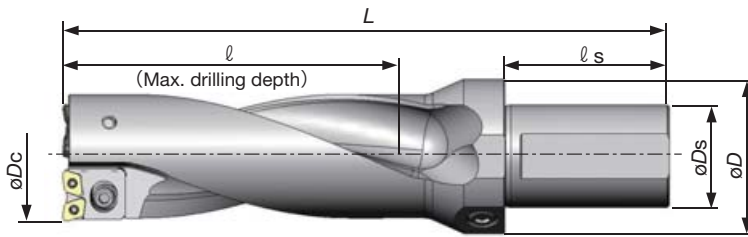

Cat. No.	Stock	Dimensions (mm)						Outer cartridge	Inner cartridge	Setting plate	Applicable inserts
		øDc	øDs	øD	l	l _s	L				
TDX55-56F50-2.5	●	55	50	75	140	80	260	TDX08CA-P0	TDX08CA-C0	/	XPMT08T308R-**
		56								AP0801	
TDX57-62F50-2.5	●	57	50	75	155	80	280	TDX08CA-P1	TDX08CA-C1	/	XPMT08T308R-**
		58								AP0801	
		59								AP0802	
		60								AP0803	
		61								AP0804	
		62								AP0805	
TDX63-66F50-2.5	●	63	50	75	165	80	295	TDX08CA-P2	TDX08CA-C2	/	XPMT08T308R-**
		64								AP0801	
		65								AP0802	
		66								AP0803	
TDX67-73F50-2.5	●	67	50	75	183	80	320	TDX11CA-P1	TDX11CA-C1	/	XPMT110412R-**
		68								AP1101	
		69								AP1102	
		70								AP1103	
		71								AP1104	
		72								AP1105	
TDX74-80F50-2.5	●	73	50	75	200	80	330	TDX11CA-P2	TDX11CA-C2	AP1106	XPMT110412R-**
		74								/	
		75								AP1101	
		76								AP1102	
		77								AP1103	
		78								AP1104	
		79								AP1105	
		80								AP1106	

Replacement Parts

Cat. No.	Screws				Washer	Wrenches			
	For cartridge (Inner, outer)	For setting plate	For insert	For sideport		For cartridge (Inner, outer)	For setting plate	For insert	For sideport
TDX55-56F50-2.5	CM5x0.8x12	CSTB-3	CSTB-3	PT1/4GN	5.3x10x1	P-4	T-9D	T-9D	P-6
TDX57-62F50-2.5									
TDX63-66F50-2.5	CM6x15		CSTB-4		6.4x12.5x1.6	P-5		T-15D	
TDX67-73F50-2.5	CM6x16								
TDX74-80F50-2.5	CM6x16								

● : Stocked items

Inserts

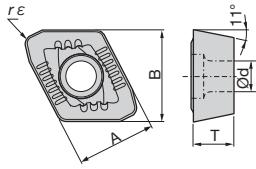
DJ chipbreaker 	Cat. No.	Stocked grades			Dimensions (mm)					Applicable drill diameters
		PREMIUMTEC AH725	AH740	PREMIUMTEC T1115	A	B	T	ød	r _ε	
		XPMT08T308R-DJ	●	●	●	8.5	9.9	3.97	3.4	
XPMT110412R-DJ	●	●	●	11.2	12.5	4.76	4.4	1.2	ø67.0 ~ ø80.0	

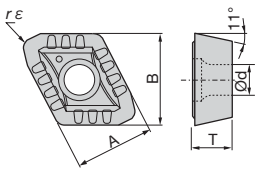
DS chipbreaker 	Cat. No.	Stocked grades		Dimensions (mm)					Applicable drill diameters
		PREMIUMTEC AH725	AH120	A	B	T	ød	r _ε	
		XPMT08T308R-DS	●	●	8.5	9.9	3.97	3.4	
XPMT110412R-DS	●	●	11.2	12.5	4.76	4.4	1.2	ø67.0 ~ ø80.0	

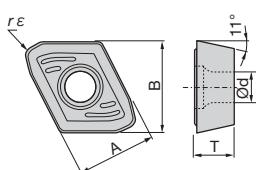
DW chipbreaker 	Cat. No.	Stocked grades			Dimensions (mm)					Applicable drill diameters
		PREMIUMTEC AH725	AH740	AH120	A	B	T	ød	r _ε	
		XPMT08T308R-DW	●	●	●	8.5	9.9	3.97	3.4	
XPMT110412R-DW	●	●	●	11.2	12.5	4.76	4.4	1.2	ø67.0 ~ ø80.0	

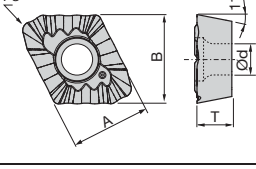
DG chipbreaker 	Cat. No.	Stocked grade	Dimensions (mm)					Applicable drill diameters
		PREMIUMTEC AH725	A	B	T	ød	r _ε	
		XPMT08T308R-DG	★	8.5	9.9	3.97	3.4	
XPMT110412R-DG	★	11.2	12.5	4.76	4.4	1.2	ø67.0 ~ ø80.0	

● : Stocked items
 ★ : Available in autumn 2011

Recommended inserts

Work materials	First choice	High feed	High speed	Troubleshooting		
				Breakage	Wear	Surface finish
Low carbon steels (C < 0.3) SS400, SM490, S25C etc. (St42-1, St52-3, C25 etc.)	DS, AH725		DJ, AH725	DS, AH120		DW, AH725
Carbon steels (C > 0.3) S45C, S55C etc. (C45, C55 etc.)	DJ, AH725	DW, AH725	DJ, AH725	DW, AH740	DJ, T1115	DW, AH725
Low alloy steels SCM415 etc. (15CrMo5 etc.)	DS, AH725		DJ, AH725	DS, AH120		DW, AH725
Alloy steels SCM440, SCr420 etc. (42CrMo4, 20Cr4 etc.)	DJ, AH725	DW, AH725	DJ, AH725	DW, AH740	DJ, T1115	DW, AH725
Stainless steels (Austenitic) SUS304, SUS316 etc. (X5CrNi18-9, X5CrNiMo17-12-2 etc.)	DS, AH725		DS, AH725	DS, AH120		DW, AH725
Stainless steels (Martensitic and ferritic) SUS430, SUS416 etc. (X5CrNi18-9, X5CrNiMo17-12-2 etc.)	DS, AH725		DS, AH725	DS, AH120		DW, AH725
Stainless steels (Precipitation hardening) SUS630 etc. (X5CrNiCuNb16-4 etc.)	DS, AH725		DS, AH725	DS, AH120		DW, AH725
Grey cast irons FC250 etc. (GG25 etc.)	DJ, AH725	DW, AH725	DJ, T1115	DW, AH740	DJ, T1115	DW, AH725
Ductile cast irons FCD700 etc. (GGG70 etc.)	DJ, AH725	DW, AH725	DJ, T1115	DW, AH740	DJ, T1115	DW, AH725
Aluminium alloys A2017, ADC12 etc.	DW, AH725	DW, AH725	DJ, AH725	DW, AH740		

Standard cutting conditions

Work materials	Cutting speed Vc (m/min)	Feed: f (mm/rev)		
		ø55 ~ ø62	ø63 ~ ø73	ø74 ~ ø80
Low carbon steels (C < 0.3) SS400, SM490, S25C etc. (St42-1, St52-3, C25 etc.)	240 (160-320)	0.07 (0.04-0.10)	0.07 (0.04-0.10)	0.07 (0.04-0.10)
Carbon steels (C > 0.3) S45C, S55C etc. (C45, C55 etc.)	140 (80-250)	0.13 (0.08-0.18)	0.13 (0.08-0.18)	0.15 (0.10-0.20)
Low alloy steels SCM415 etc. (15CrMo5 etc.)	210 (160-250)	0.10 (0.04-0.16)	0.10 (0.04-0.16)	0.10 (0.04-0.16)
Alloy steels SCM440, SCr420 etc. (42CrMo4, 20Cr4 etc.)	140 (80-200)	0.13 (0.08-0.18)	0.13 (0.08-0.18)	0.14 (0.08-0.20)
Stainless steels (Austenitic) SUS304, SUS316 etc. (X5CrNi18-9, X5CrNiMo17-12-2 etc.)	150 (100-200)	0.08 (0.04-0.12)	0.08 (0.04-0.12)	0.10 (0.06-0.14)
Stainless steels (Martensitic and ferritic) SUS430, SUS416 etc. (X5CrNi18-9, X5CrNiMo17-12-2 etc.)	160 (100-200)	0.08 (0.04-0.12)	0.08 (0.04-0.12)	0.10 (0.06-0.14)
Stainless steels (Precipitation hardening) SUS630 etc. (X5CrNiCuNb16-4 etc.)	100 (80-120)	0.08 (0.04-0.10)	0.08 (0.04-0.10)	0.09 (0.06-0.12)
Grey cast irons FC250 etc. (GG25 etc.)	170 (80-250)	0.14 (0.08-0.20)	0.14 (0.08-0.20)	0.16 (0.10-0.22)
Ductile cast irons FCD700 etc. (GGG70 etc.)	140 (80-200)	0.14 (0.08-0.20)	0.14 (0.08-0.20)	0.16 (0.10-0.22)
Aluminium alloys A2017, ADC12 etc.	300 (200-400)	0.20 (0.15-0.25)	0.20 (0.15-0.25)	0.23 (0.18-0.28)

Standard cutting conditions for DG chipbreaker

Work materials	Cutting speed Vc (m/min)	Feed: f (mm/rev)
		ø55 ~ ø80
Low carbon steels (C < 0.3) SS400, SM490, S25C etc. (St42-1, St52-3, C25 etc.)	100 (60 - 180)	0.07 (0.04-0.10)

Caution

Machine

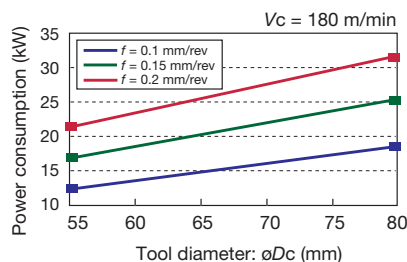

- Use drills on a fully covered machine to maintain safety.
- Use drills on a high powered machine such as a BT50.
- Figure on right shows reference of required machine power.



Cutting coolant

- Use water soluble type coolant with internal supply.
- Coolant pressure higher than 1MPa is essential.

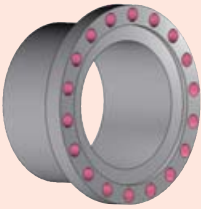
Practical examples

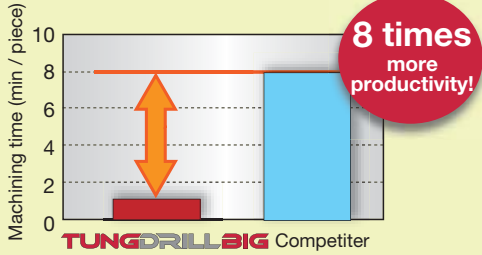
Workpiece type		Flange on tube	Housing of machine
Drill		TDX74-80F50-2.5	TDX67-73F50-2.5
Insert		XPMT110412R-DJ	XPMT110412R-DJ
Grade		AH725	AH725
Work material		FCD450 / GGG45	FCD450 / GGG45
			
Cutting conditions	Cutting speed: V_c (m/min)	150	120
	Feed: f (mm/rev)	0.15	0.15
	Tool diameter: ϕD_c (mm)	$\phi 80$	$\phi 70$
	Drilling depth: H (mm)	80	80
	Coolant	MQL (Internal)	Wet (Internal)
Results		 <p>The stable drilling of TungDrillBig significantly reduces scratches in the hole wall. The AH725 grade provides 4 times longer tool life than its competitors.</p>	 <p>TungDrillBig provides 8 times higher productivity than current HSS drill.</p>



Tungaloy Corporation

Tungaloy Corporation (Head office)
11-1 Yoshima-Kogyodanchi
Iwaki-city, Fukushima, 970-1144 Japan
Phone: +81-246-36-8501 Fax: +81-246-36-8542
www.tungaloy.co.jp

Tungaloy America, Inc.
Phone: +1-888-554-8394 Fax: +1-888-554-8392
www.tungaloyamerica.com

Tungaloy Canada
Phone: +1-519-758-5779 Fax: +1-519-758-5791
www.tungaloyamerica.com

Tungaloy de Mexico S.A.
Phone: +52-449-929-5410 Fax: +52-449-929-5411
www.tungaloyamerica.com

Tungaloy do Brasil Comércio de Ferramentas de Corte Ltda.
Phone: +55-19-38262757 Fax: +55-19-38262757
www.tungaloy.co.jp/br

Tungaloy Germany GmbH
Phone: +49-2173-90420-0 Fax: +49-2173-90420-19
www.tungaloy.de

Tungaloy France S.A.S.
Phone: +33-1-6486-4300 Fax: +33-1-6907-7817
www.tungaloy.fr

Tungaloy Italia S.r.l.
Phone: +39-02-252012-1 Fax: +39-02-252012-65
www.tungaloy.it

Tungaloy Czech s.r.o
Phone: +420 532 123 391 Fax: +420 532 123 392
www.tungaloy.cz

Tungaloy Ibérica S.L.
Phone: +34 93 1131360 Fax: +34 93 1131361
www.tungaloy.es

Tungaloy Scandinavia AB
Phone: +46-462119200 Fax: +46-462119207
www.tungaloy.co.jp/se

Tungaloy Rus, LLC
Phone: +7 4722 58 57 57 Fax: +7 4722 58 57 83
www.tungaloy.co.jp/ru

Tungaloy Polska Sp. z o.o
Phone: +48-22-617-0890 Fax: +48-22-617-0890
www.tungaloy.co.jp/pl

Tungaloy UK Ltd
Phone: +44 121 309 0163 Fax: +44 121 270 9694
www.tungaloy.co.jp/uk

Tungaloy Cutting Tool (Shanghai) Co.,Ltd.
Phone: +86-21-3632-1880 Fax: +86-21-3621-1918
www.tungaloy.co.jp/tcts

Tungaloy Cutting Tool (Thailand) Co.,Ltd.
Phone: +66-2-714-3130 Fax: +66-2-714-3134
www.tungaloy.co.th

Tungaloy Singapore (Pte.),Ltd.
Phone: +65-6391-1833 Fax: +65-6299-4557
www.tungaloy.co.jp/tspl

Tungaloy India Pvt. Ltd.
Phone: +91-22-6124-8804 Fax: +91-22-6124-8899
www.tungaloy.co.jp/in

Tungaloy Korea Co., Ltd
Phone: +82-2-6393-8930 Fax: +82-2-6393-8952
www.tungaloy.co.jp/kr

Tungaloy Malaysia Sdn Bhd
Phone: +603-7805-3222 Fax: +603-7804-8563
www.tungaloy.co.jp/my

Tungaloy Australia Pty Ltd
Phone: +612-9672-6844 Fax: +612-9672-6866
www.tungaloy.co.jp/au



ISO 9001 certified
QC00J0056
Tungaloy Corporation
18/10/1996

ISO 14001 certified
EC97J1123
Tungaloy Group
Japan site and Asian
production site
26/11/1997

Distributed by:



068 85978